

CHIARO CHAIR

design by **LEON RANSMEIER**

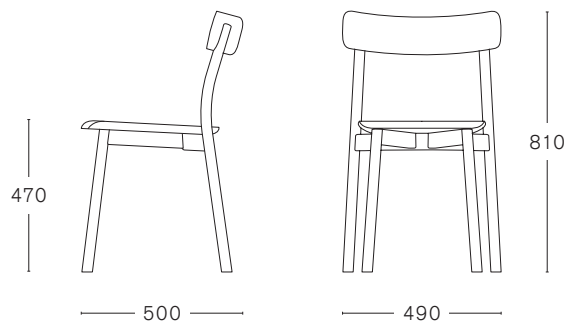

TECHNICAL INFORMATION

STACKABLE



MAX. PER BOX
2 CHAIRS

GROSS WEIGHT
CA. kg 14,00

VOLUME
0,32 m³

BOX SIZE
535 x 630 x 955 mm

FINISHINGS

ASH

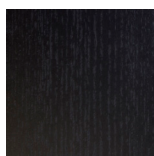

BLACK

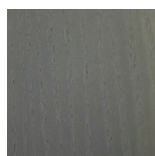

GREY



WHITE

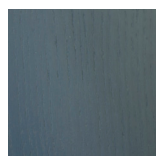

BLUE

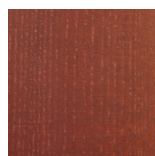

DARK RED

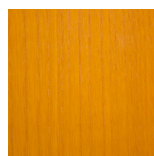

YELLOW



NATURAL

OAK



NATURAL

FABRIC UPHOLSTERY

ROHI NOVUM

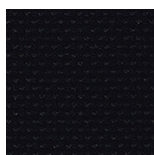

EBONY

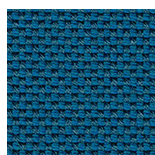

AZUR

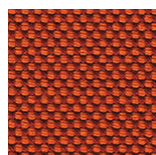

CORAL

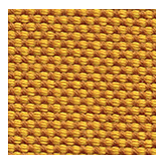

CURRY

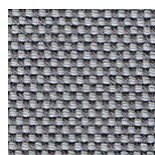

KIES

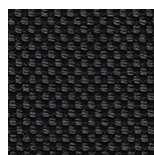

LANOSO

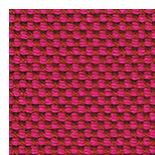

MAGENTA



PRUNE

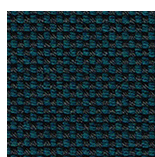

SAMOA



SNOW

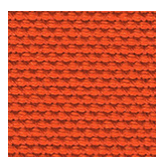

SUNSET

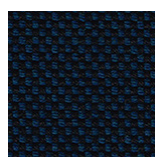

AMUR

CHIARO ARMCHAIR

design by **LEON RANSMEIER**

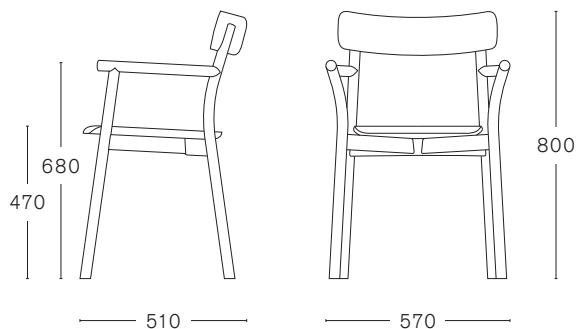

TECHNICAL INFORMATIONS

STACKABLE



MAX. PER BOX
2 CHAIRS

GROSS WEIGHT
CA. kg 15,00

VOLUME
0,38 m³

BOX SIZE
630 x 630 x 955 mm

FINISHINGS

ASH

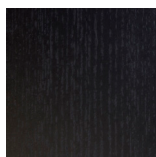

BLACK

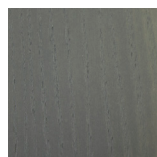

GREY



WHITE



BLUE

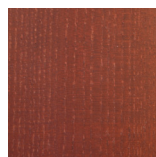

DARK RED

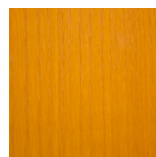

YELLOW



NATURAL

OAK



NATURAL

FABRIC UPHOLSTERY

ROHI NOVUM

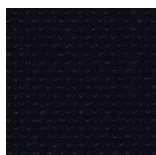

EBONY

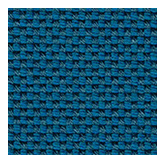

AZUR

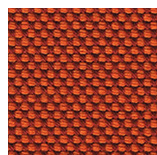

CORAL

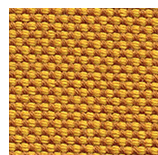

CURRY

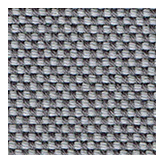

KIES

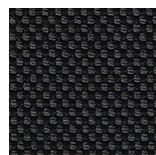

LANOSO

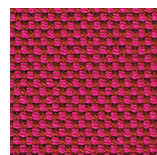

MAGENTA

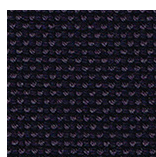

PRUNE

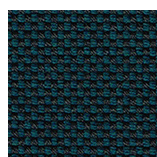

SAMOA

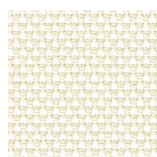

SNOW

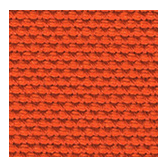

SUNSET

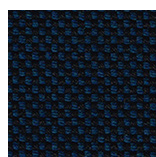

AMUR